



Happy brands

PENS & NOTEBOOKS

ECO

KIKI GREEN  14

KIKI ECO  16

RE-PEN PUSH  18

WRAP PACK  20

ECO SLEEVE  21

SAFETOUCH

GOLFF SAFETOUCH  24

KIKI SAFETOUCH  26

SLEEVE SAFETOUCH  28

SPECIAL SERVICES

X-FIVE SWING  32

X-FIVE FANTASY  34

GOLFF FANTASY  34

KIKI FANTASY  34

TRIS FANTASY  34

PMS PRODUCTION 38

OTTO CLIP
LOGO STANDARD  40

OTTO CLIP
LOGO SPECIAL  40

AIRY CLIP
LOGO STANDARD  40

AIRY CLIP
LOGO SPECIAL  40

FUTURA DIGITAL  44

IMAGE BOX  46

DRESS PACK  47

PROMOTIONAL

FORTE  NEW 50

X-NINE  58

NOVE  58

FUTURA  62

X-FIVE  64

TRIS  68

GOLFF  72

KIKI  76

OTTO  80

JOCKER  84

X-ONE  85

TWIN  90

TWISTY  94

FLAG  96

Plastic pens add value

AUTHENTIC ITALIAN BRAND WITH HISTORY

Brand Lecce Pen® was founded 60 years ago in Italy and its distinguishing design still remains synonymous with Italian style and quality. Thanks innovation, we are probably one of the most recognizable international brand of promotional products. We believe that our pens can fit perfectly into the character and design of brands it represents. That's why we try to offer more opportunities than others. That is why each of our products has an added value, making it easier for you to express your brand. **Express your brand!**



RU

Пластиковые ручки с дополнительной ценностью

Бренд Lecce Pen® был основан в Италии 60 лет назад. Его отличительный дизайн до сих пор остается синонимом итальянского стиля и качества. Благодаря инновациям мы являемся производителями, пожалуй, самого узнаваемого международного бренда рекламной продукции. Мы убеждены, что наши ручки могут идеально сочетаться с брендами, которые они представляют. Именно поэтому мы стараемся предложить больше решений, чем другие. Каждый продукт имеет значение, которое поддерживает коммуникацию вашего бренда. **Выразите Ваш бренд!**

PL

Długopisy plastikowe dodają wartości

Marka Lecce Pen® powstała 60 lat temu we Włoszech, a wyróżniające ją wzornictwo wciąż sprawia, że pozostaje synonimem włoskiego stylu i najwyższej jakości. To dzięki innowacyjności jesteśmy najprawdopodobniej jedną z najbardziej rozpoznawalnych, międzynarodowych marek producentów produktów promocyjnych. Wierzymy, że produkt reklamowy może idealnie pasować do charakteru i designu marki, którą reprezentuje. Dlatego staramy się oferować więcej możliwości niż inni. Dlatego każdy nasz produkt ma wartość dodaną, dzięki czemu łatwiej możesz wyrazić swoją markę. **Express your brand!**

DE

Kunststoff-Kugelschreiber mit einer Mehrwert

Lecce Pen® wurde vor 60 Jahren in Italien gegründet und sein Design ist ein Synonym für italienischen Stil und Qualität. Durch kontinuierliche Innovation, wir sind eine der bekanntesten internationalen Marken in der Panorama der Werbeartikel von Schreiben. Wir glauben, dass unsere Stifte sind ideal, um unsere Marke zu repräsentieren. Aus diesem Grund versuchen wir, mehr Lösungen zu anbieten. Jedes Produkt hat einen Wert, der die Kommunikation Ihrer Marke unterstützt. **Verbreiten Sie Ihre Marke!**

SPECIAL SERVICE



Swing

[ru] Swing

[pl] Swing

[de] Swing



The rotate inner tube inside the pen let moving text message in 6 lines. Variant depends of colours possible to assembly in Standard, Fantasy or special colors – PMS

Вращающийся внутри ручки барабанчик позволяет прочитать до 6 разных текстовых сообщений. Варианты ручек возможны как в стандартных цветах Fantasy, так и в специальных на выбор.

Rotująca tuba wewnątrz długopisu umożliwia przesuwanie tekstów w 6 liniach. Wersja zależy od montażu kolorystycznego: Standard, Fantasy lub PMS.

Das rotierende Innenröhrchen bringt Bewegung in Ihre Werbung. Erhältlich in der Standard, Fantasy und PMS Ausführung.



Fantasy – mix and match

Fantasy – смешивать и сочетать

Fantasy – miksuj i łącz

Fantasy – mischen und anpassen



It allows to conform the colors of chosen elements of the pen to client's individual needs. Taints are chosen from the Lecce Pen color palette available for certain model.

Сборка ручек по выбранным заказчиком цветам на основе стандартной палитры Lecce Pen, доступной для данной модели.

Pozwala na dopasowanie kolorów wybranych elementów długopisu do indywidualnych potrzeb klientów. Barwy wybierane są z palety kolorów Lecce Pen dostępnej dla konkretnego modelu.

Lässt das Anpassen der Farben der ausgewählten Einzelteile des Kulis zu den individuellen Bedürfnissen des Kunden. Die Farben werden für ein konkretes Modell aus einer Lecce Pen Farbpalette ausgewählt.



Special production PMS

Специальное производство PMS

PMS produkcja specjalna

PMS Sonderherstellung



Pens are in unusual colors. The shades are chosen from the Pantone Matching System.

Ручки нестандартных цветов. Оттенки могут быть выбраны из палитры Pantone Matching System

Produkcja długopisów w kolorze niestandardowym. Barwy wybierane są z palety Pantone Matching System.

Kugelschreiberherstellung in keiner Standardfarbe. Die Farben werden aus der Palette Pantone Matching System gewählt.



Custom packaging

УПАКОВКА

Opakowanie

Verpackungsangebot



We offer individual solutions as far as the packaging of our pens is concerned. No matter whether it is single poly bag or cardboard case with the shape and overprint adjusted to client's preferences.

Готовые решения для упаковки письменных принадлежностей. Дизайн может быть создан по макету заказчика.

Proponujemy indywidualne rozwiązania w zakresie pakowania naszych długopisów. Od pojedynczych foliowych woreczków do tekturowego etui w kształcie i z nadrukiem zgodnie z preferencjami klienta.

Wir bieten individuelle Lösungen im Bereich der Verpackung unserer Kulis an. Von den einzelnen Plastiktüten bis hin zu den Pappetuis. Die Form und der Aufdruck gemäß den Kundenanforderungen.



Standard logo clip Special logo clip



Apart from a wide range of standard clip shapes, we also make special clips based on our client's design. The immediate associations that logo clips evoke help to identify with a brand.

[ru] Стандартный лого-клип Специальный лого-клип

Помимо широкого спектра стандартных форм клипа, мы делаем клипы нестандартной формы по макету заказчика. Это позволяет быстро идентифицировать бренд среди конкурентов.

[pl] Klip logo standard Klip logo specjalny

Produkcja klipsów specjalnych na podstawie projektu Klienta lub możliwość wyboru z dostępnych standardowo kształtów. Pozwala na szybką identyfikację z marką dzięki bezpośrednim skojarzeniom.

[de] Kauf logo standard Kauf logo sonder

Die Herstellung von Sonderklemmen aufgrund des Kundenprojektes oder die Wahlmöglichkeit der vorhandenen Gestalten.



Polymeric sticker



Polymeric sticker is a convex 3D label covered with a two-ingredient polyurethane resin or epoxy resin. The sticker is placed both on a standard clip and on a special clip designed by the client.

Полимерный стикер

это трехмерная этикетка, покрытая двойным слоем полиуретана или эпоксидной смолы. Наклейка может быть размещена на стандартном клипе, либо на клипе, созданном по макету клиента.

Naklejka polimerowa

Jest to wypukła etykieta 3D, pokryta dwuskładnikową żywicą poliuretanową lub żywicą epoksydową. Naklejka umieszczana jest zarówno na klipsie standardowym, jak również na klipsie specjalnym, projektowanym przez klienta.

Polymeretikette

Polymeretikette- ist eine gewölbte Etikette 3D mit Doppeltzusatzharz oder mit Epoxidharz beschichtet. Die Etikette befindet sich sowohl auf der Standardklemme, als auch der Klemme, die selbst von den Kunden entwirft wird.



Satinated



Exclusive style at a low price. Pens with a satin finish gain an elegant and original look.

Сатинирование

Покрытие всей ручки специальной краской. После сатинирования ручка получает эксклюзивный внешний вид за приемлемые деньги.

Satynowanie

Ekskluzywny wygląd niewielkim kosztem. Dzięki satynowaniu długopis uzyskuje elegancki i oryginalny wygląd.

Satinieren

Exklusives Aussehen für wenig Geld. Dank des Satiniens bekommt der Kugelschreiber elegantes und originelles Aussehen.



Refill choice



Italian refills, German Dokumental® ink in black or blue depending on the individual need. Gel available on request.

Стержень на выбор

Итальянские стержни и немецкие сертифицированные чернила Dokumental® в черном и синем цветах в зависимости от ваших нужд. Гелевые стержни доступны по запросу.

Wkłady

Włoskie wkłady z niemieckim tuszem Dokumental® w niebieskim lub czarnym kolorze. Wkłady żelowe na specjalne zamówienie.

Minenwahl

Italienische Minen, deutsche Dokumental® wahlweise in schwarz oder blau. Gel-Mine ist auf Anfrage.

PRINTING



Digital overprinting 360°

360° is perfect for your creativity. Digital foil allows you to recreate photos on the whole surface of product's body. This offer relates to the following models: FUTURA.

[ru] Цифровая печать 360°

идеально подходит для вашего творчества. Цифровая фольга позволяет создать фотографии на всей поверхности корпуса ручки. Это предложение относится к моделям: FUTURA.

[pl] Nadruk cyfrowy 360°

360° dla Twojej kreatywności. Folia cyfrowa umożliwia odtworzenie zdjęć na całej powierzchni korpusu. Oferta dotyczy modeli: FUTURA.

[de] Digitalaufdruck 360°

360 Grad für deine Kreativität. Digitalfolie ermöglicht Fotos auf ganzer Korpusfläche widerzugeben. Das Angebot betrifft: FUTURA.



Digital overprint

Fully colored digital overprint on flat surfaces allows for tonal transitions.

Цифровая печать

Полностью цветная цифровая надпись на плоских поверхностях, позволяет делать тональные переходы.

Nadruk cyfrowy

Pełno kolorowy nadruk cyfrowy na płasko. Pozwala na uzyskanie przejść tonalnych.

Der Digitalaufdruck

Der Digitalaufdruck, ein vollbunter Digitalflachaufdruck. Er lässt einen Tonalitätsänderung zu erreichen .



Brocade decoration

A special type of printing using colored brocade. This type of printing can be done over the entire circumference of the pen.

Брокад

Обыый вид шелкотрафаретной печати. При таком способе изображение наносится специальными красками с металлизированными пигментами (блестками). Возможна круговая печать.

Nadruk brokatowy

Specjalny rodzaj nadruku wykonywany kolorowym brokatem. Usługa może być wykonywana na całym obwodzie długopisu.

Brokatdruck

Sonderdruckart mit farbigem Brokat gemacht. Diese Dienstleistung kann auf dem ganzen Umfang des Kugelschreibers gemacht werden.



Round overprint 360°

[ru] Круговая печать 360°

[pl] Nadruk na okrągło 360°

[de] Rotationsdruck 360°



Screen printing process allowing for printing on round surfaces. This increases the printable space for advertisements due to the ability to print around the entire circumference of the pen.

Технология трафаретной печати, позволяющая практически на 360 градусов запечатать поверхность шариковой ручки.

Technika sitodruku pozwala na zadruk zaokrąglonych powierzchni. Zwiększa to pole prezentacji reklamy na przedmiocie, dzięki możliwości druku po pełnym obwodzie długopisu.

Die Siebdrucktechnik ermöglicht runde Flächen zu bedrucken. Das vergrößert die Werbefläche auf dem Gegenstand, dank der Druckmöglichkeit auf dem ganzen Umfang des Kugelschreibers.



Silkscreen printing

Шелкотрафаретная печать

Sitodruk

Siebdruck



A printing process for single and multi-colored labeling of writing utensils and other marketing items composed of various materials (plastic or metal).

Самый популярный вид трафаретной печати, позволяющий делать нанесение рекламных изображений на продукцию из разнообразных материалов (пластик, текстиль и т.д.).

To jedna z technik drukowania stosowana do jedno i wielokolorowego znakowania artykułów piśmienniczych o różnej powierzchni (plastik, metal) oraz innych gadżetów reklamowych.

Es ist eine von den Drucktechniken, die zum ein- oder mehrfarbigen bezeichnen der Schreibwaren mit verschiedenen Flächen wie zB. (Kunststoff, Metal) oder anderen Werbesachen dient.



Pad printing

Тампонная печать

Tampodruk

Tampondruck



A printing process for small, often uneven surfaces. It can be used for printing on many different types of artificial materials, metal, or wood.

Способ печати, при котором краска наносится на изделие с помощью эластичного тампона. Оптимально подходит для запечатывания прямых и изогнутых поверхностей из пластика, металла.

Technika druku na małych, niekoniecznie płaskich, powierzchniach. Nadaje się do znakowania różnego rodzaju tworzyw sztucznych, metalu czy drewna.

Eine Drucktechnik, auf kleinen, nicht unbedingt flachen Flächen verwendet. Eignet sich für verschiedenes Kunststoff, Metal, oder Holzmaterial.

The **biodegradable** material solves problem of items arrived to the end of its cycle of the life, and **does not generate waste.**



[en] BIOPLAST®, an entirely biodegradable biomaterial derived from natural sources, is the answer for consumers searching for products with minimal environmental impact. BIOPLAST® is a biodegradable material created from renewable plant resources that does not contain petroleum-based substances. BIOPLAST® returns to the natural environment after undergoing biodegradation and composting without leaving behind substances harmful to the environment. BIOPLAST® reduces gas emissions and the greenhouse effect, has no negative effects on the environment, and reduces energy consumption.

[ru] BIOPLAST® – пластик нового поколения, созданный на основе растительных материалов и полностью пригодный к переработке. Он не содержит продуктов переработки нефти и обладает высокой скоростью разложения под влиянием природных биологических факторов. Использование биоразлагаемых пластических масс с применением крахмала позволяет не только экономить природные ресурсы, но и предотвратить загрязнение окружающей среды.

[pl] Całkowicie biodegradowalne tworzywo, pochodzenia naturalnego, BIOPLAST®, jest odpowiedzią na potrzeby konsumentów szukających produktów o minimalnym negatywnym wpływie na środowisko. BIOPLAST® to materiał biodegradowalny uzyskany z odnawialnych źródeł pochodzenia roślinnego. Nie zawiera pochodnych ropy naftowej. BIOPLAST® powraca do środowiska naturalnego w wyniku biodegradacji, podczas procesu kompostowania, bez pozostawiania substancji szkodliwych dla natury. BIOPLAST® zmniejsza emisję gazów i efekt cieplarniany. Nie dewastuje środowiska naturalnego, a także zmniejsza zużycie energii.

[de] Ganz bioabbaubares Bio-Naturmaterial: BIOPLAST® ist die Antwort auf die Bedürfnisse der Verbraucher, die solche Produkte suchen, die minimalen Einfluß auf die Umwelt haben. BIOPLAST® ist ein bioabbaubares Material, das aus erneuerbaren pflanzlichen Quellen gewonnen wurde. Es enthält keine Erdölsubstanzen. BIOPLAST® kommt in die Umwelt zurück nach dem Bioabbau und Kompostierung, ohne naturschädliche Substanzen zu hinterlassen. BIOPLAST® vermindert die Gasemission und Treibhauseffekt, zerstört die Umwelt nicht und vermindert Energieverbrauch.



The **recycled** material help to **convert waste materials** into reusable material to prevent waste of potentially useful materials.

[en] In accordance with the needs of the market, Out of concern for the natural environment. EcoLine was created to reduce the disposal costs of polyethylene and aluminum, which are byproducts of the process of separating out cellulose during the recycling of beverage cartons. Our aim was to utilize the waste material and transform it into the innovative EcoLine material, made from polyethylene and a small amount of aluminum. Thanks to advanced technology, we have created a new and innovative recycled raw material with a wide array of applications.

[ru] Мы всегда отвечаем на потребности рынка. Мы создаем эффективные решения для бизнеса. Мы заботимся об окружающей среде. EcoLine был создан в связи с необходимостью снижения затрат на утилизацию полиэтилена, алюминия – продуктов, отделяемых от волокон целлюлозы в процессе переработки упаковок от пищевых продуктов.

[pl] Zgodnie z potrzebą rynku, w trosce o środowisko naturalne. EcoLine został stworzony, by zredukować koszty utylizacji polietylenu i aluminium, które są pozostałością procesu separacji celulozy w procesie recyklingu kartoników po napojach. Naszym celem było wykorzystanie materiału odpadowego i przekształcenie go w innowacyjny materiał EcoLine, składający się z polietylenu i niewielkiej ilości aluminium. Dzięki zaawansowanej technologii powstaje nowy i innowacyjny surowiec wtórny o szerokim zastosowaniu.

[de] Den Marktbedürfnissen gemäß und in der Sorge um die Umwelt. EcoLine wurde gemacht, um die Polyäthylen – und Aluminiumverwertungskosten zu senken, die nach der Zellose-separation nach dem Getränkekartons-recyclingsverfahren bleiben. Unser Ziel war Wiederverwenden des Abfallmaterials und seine Umgestaltung in ein modernes Material EcoLine, das aus Polyäthylen und kleinen Mengen Aluminium besteht. Dank der modernen Technologie entsteht ein neuer Sekundärrohstoff, den man in vielen Bereichen verwenden kann.

Biodegradable



Standard printing

BIODEGRADABLE

Round overprint 360°
Brocade decoration
Silkscreen printing

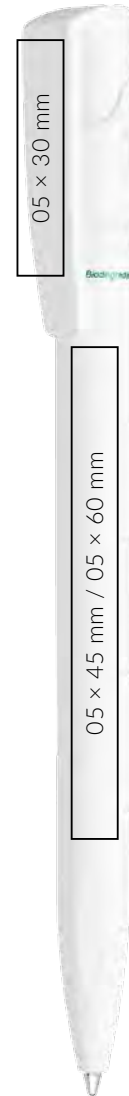

Pad printing
Digital overprint

05 x 45 mm
Pad printing
05 x 60 mm
Digital overprint

Size

11 x 144 mm

Material

Bioplast®

Finishing

White solid barrel,
colored accessories

Mechanism

Push

Ink colors

Blue – standard
Black – on demand

Refill type

Model: **X-20**
Ink. Dokumental

Optional refill

Model: **Parker type refill**
Ink. Dokumental
MOQ: 1.000

Model: **Parker type gel**
Ink. Dokumental
MOQ: 1.000

Model: **Jumbo refill**
Ink. Dokumental
MOQ: 1.000

Packing

40/1600

Kiki Green

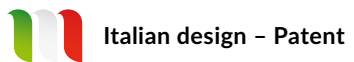



Product Code

Kiki Green 395MB..W

For other versions of Kiki see pages 16, 35, 76
To download the photos of HR&LR visit us at www.leccepen.eu



Recycled

ecLine



Round overprint 360°
Silkscreen printing



Pad printing
Digital overprint

05 x 45 mm
Pad printing

Size

11 × 144 mm

Material

Ecoline

Finishing

Solid barrel & colored accessories

Mechanism

Push

Ink colors

Blue – standard
Black – on demand

Refill type

Model: **X-20**
Ink. Dokumental

Optional refill

Model: **Parker type refill**
Ink. Dokumental
MOQ: 1.000

Model: **Parker type gel**
Ink. Dokumental
MOQ: 1.000

Model: **Jumbo refill**
Ink. Dokumental
MOQ: 1.000

Packing

40/1600

Kiki Eco



Italian design – Patent



EU Production



Security plastic



Dokumental Ink



392EW..W



392EB..W

Product Code

Kiki Eco 392EW..W / 392EB..W

For other versions of Kiki see pages 14, 35, 76
To download the photos of HR&LR visit us at www.leccepen.eu



Recycled

ecLine



28 x 45 mm

Round overprint 360°
Silkscreen printing



05 x 45 mm

Pad printing

Size

11 x 140 mm

Material

Ecoline

Finishing

Solid barrel & colored accessories

Mechanism

Push

Ink colors

Blue – standard
Black – on demand

Refill type

Model: **X-20**
Ink. Dokumental

Optional refill

Model: **Jumbo refill**
Ink. Dokumental
MOQ: 1.000

Packing

40/1600

Re-Pen Push



Italian design – Patent



EU Production



Security plastic



Dokumental Ink

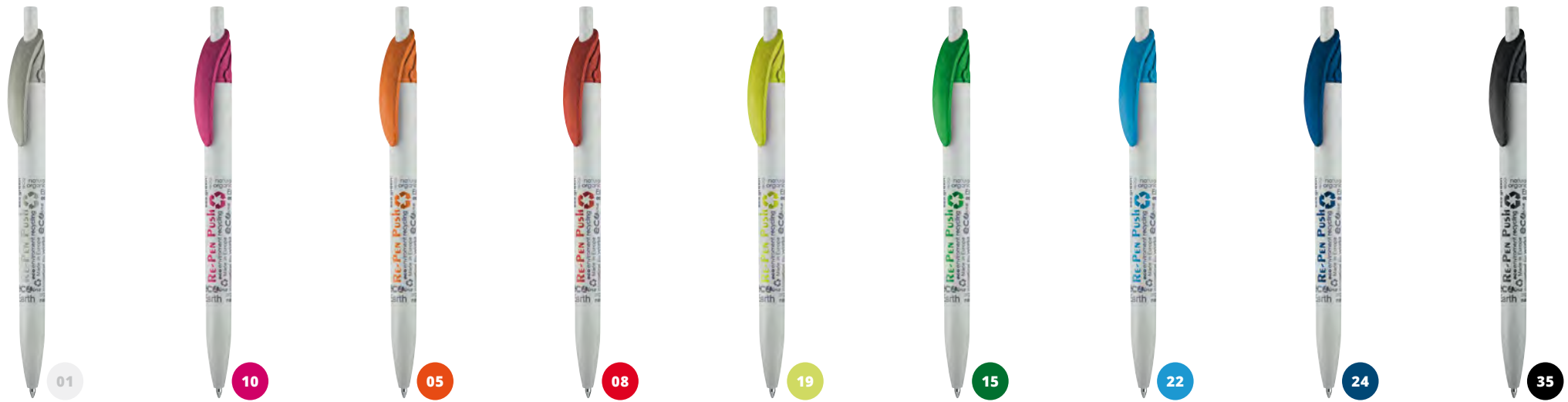

102EW..W



102EB..W

Product Code

Re-Pen Push 102EW..W / 102EB..W



WRAP PACK

Cardboard single pack

Power of communication – use new and wide space to share your promotional messages. Both, for creating brand image and promote product's details let you show itself as eco-friendly using paper.

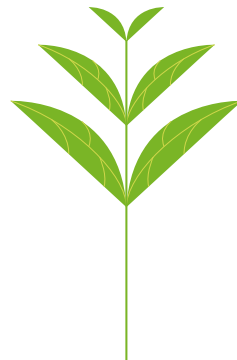
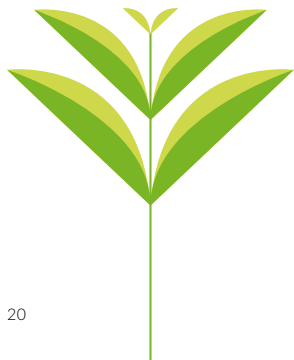

120 × 160 mm
WRAP PACK

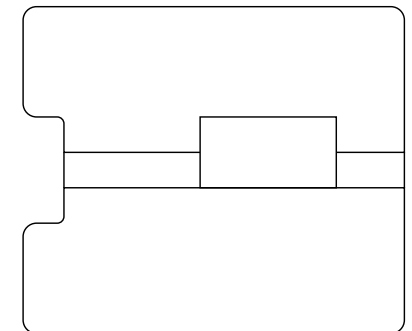

ECO SLEEVE

Single pack

is a new promotional idea that allows us to pack your pen with a leaflet in a sealed single bag, that preserves your products integrity. The leaflet give more space to your communication:
your logo, brand, the company, advertising messages, product images and services of every kind of scope.



105 x 160 mm
ECO SLEEVE

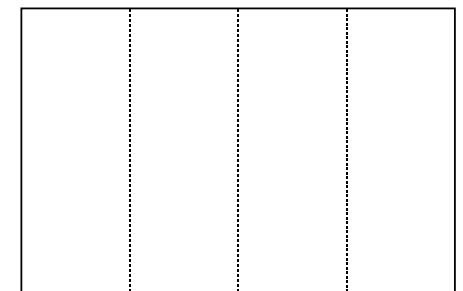



SAFE ANTIBACTERIAL

CREATED WITH CARE FOR THE HUMAN SMILE. MAKE SURE TO BE ALWAYS ON THE FACES OF YOUR CUSTOMERS. TAKE RESPONSIBILITY FOR THEIR HEALTH AND SAFETY. SELECT A SAFETOUCH.

[en] We have created our new collection to cultivate that human smile that will always find its way onto the faces of your customers. We have sought to establish ourselves as a socially responsible firm by taking responsibility for their health and safety. The SafeTouch collection is an ideal solution for places that must be clean and sterile, such as hospitals, pharmacies, clinics, and laboratories. It is also suited for public areas

where pens pass from hand to hand, as an antibacterial material added to the plastic is active for the entirety of each pen's product lifecycle. This antibacterial benefit has been confirmed and certified.

[ru] Мы заботимся о своих клиентах и предлагаем им не только качественный, но и безопасный товар. SafeTouch – инновационное решение для бизнеса, максимально способствующее снижению негативного воздействия на человека. Ручка SafeTouch специально создана для таких мест, где все должно быть чисто и стерильно, например, для аптек и поликлиник. Она прекрасно

дополнит места массового оформления документов. Антибактериальный эффект сохраняется на протяжении всего периода ее использования. По всем тестам показаны превосходные результаты, подтверждающие высокое качество и антибактериальные свойства продукции. Товар сертифицирован по европейским стандартам.

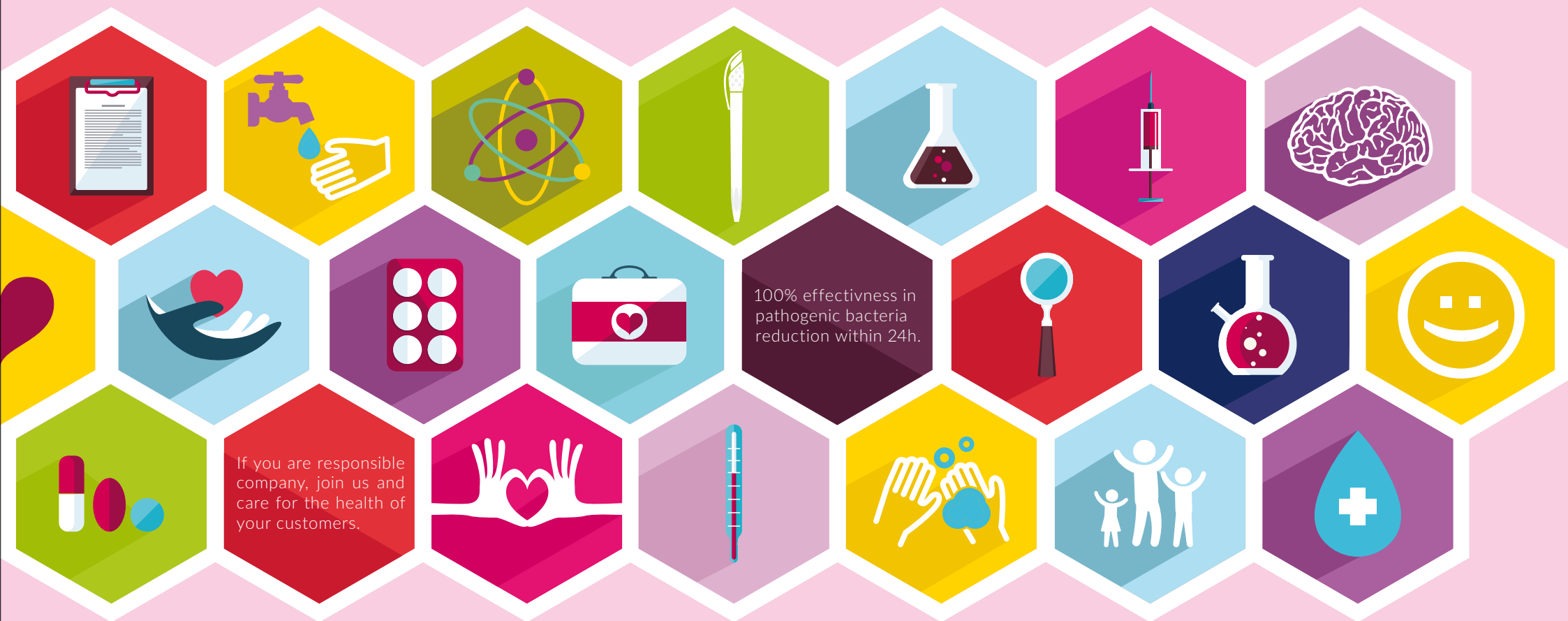

[pl] Stworzyliśmy nową kolekcję z dbałością o ludzki uśmiech, by zawsze gościł na twarzach Twoich klientów. Biorąc odpowiedzialność za ich zdrowie i bezpieczeństwo realizujemy się jako firma odpowiedzialna społecznie. Kolekcja SafeTouch – to idealne rozwiązanie do miejsc, gdzie musi być czysto i sterylne, takich jak: szpitale, apteki, przychodnie czy laboratoria. Sprawdza się

również w miejscach publicznych, gdzie długo-
pis przechodzi z rąk do rąk, ponieważ dodatek
antybakteryjny zawarty w plastiku jest aktyw-
ny przez cały okres użytkowania długopisu.
Działanie zostało potwierdzone certyfikatem.

[de] Wir haben neue Mustersammlung mit Sorge
um das Lächeln auf den Gesichtern Deiner
Kunden gebildet. Da wir die Verantwortung
für ihre Gesundheit und Sicherheit tragen, re-
alisieren wir uns als gesellschaftsverantwor-
tliche Firma. Die SafeTouch Sammlung – ist
ideale Lösung für Plätze, wo es immer sau-
ber und ordentlich sein muss, wie zB: in den
Krankenhäusern, Apotheken, Polikliniken oder

Labors. Es bewährt sich auch sehr gut in den
öffentlichen Plätzen, wo ein Kugelschreiber
von Hand zu Hand geht, da der antibakteri-
elle Zusatzmaterial in dem Kunststoff ständig
aktiv ist, während des Kuligebrauchs. Diese
Wirkung wurde mit einem Zertifikat bestätigt.

Antibacterial

SafeTouchTM
a n t i b a c t e r i a l



Standard printing

ANTIBACTERIAL

28 x 45 mm

Round overprint 360°
Brocade decoration
Silkscreen printing



05 x 23 mm
05 x 19 mm

05 x 23 mm
Pad printing
05 x 19 mm
Digital overprint

05 x 45 mm / 05 x 60 mm

05 x 45 mm
Pad printing
05 x 60 mm
Digital overprint

Size

11 x 147 mm

Material

Antibacterial

Finishing

Solid, monocolored

Mechanism

Push

Ink colors

Blue - standard
Black - on demand

Refill type

Model: **X-20**
Ink. Dokumental

Optional refill

Model: **Parker type refill**
Ink. Dokumental
MOQ: 1.000

Model: **Parker type gel**
Ink. Dokumental
MOQ: 1.000

Model: **Jumbo refill**
Ink. Dokumental
MOQ: 1.000

Packing

35/1400

PMS Services

MOQ: 15.000

Golff SafeTouch



Italian design - Patent



EU Production



Security plastic



Dokumental Ink



01



102



103



105



106

Product Code

Golff SafeTouch 410ST..W

For other versions of Golff see pages 35, 72
To download the photos of HR&LR visit us at www.leccepen.eu



Antibacterial

SafeTouchTM
a n t i b a c t e r i a l



Standard printing

ANTIBACTERIAL

Round overprint 360°
Brocade decoration
Silkscreen printing



05 x 23 mm
Pad printing
05 x 19 mm
Digital overprint

05 x 45 mm
Pad printing
05 x 60 mm
Digital overprint

Size

10,5 x 143 mm

Material

Antibacterial

Finishing

Solid, monocolored

Mechanism

Twist

Ink colors

Blue - standard
Black - on demand

Refill type

Model: **X-20**
Ink. Dokumental

Optional refill

Model: **Jumbo refill**
Ink. Dokumental
MOQ: 1.000

Packing

50/2000

PMS Services

MOQ: 15.000

Twisty SafeTouch



Italian design - Patent



EU Production



Security plastic



Dokumental Ink



Product Code

Twisty SafeTouch 176ST..W

For other versions of Twisty see page 94
To download the photos of HR&LR visit us at www.leccepen.eu



Sleeve SafeTouch

Single pack

is a new promotional idea that allows us to pack your pen with a leaflet in a sealed single bag, that preserves your products integrity. The leaflet give more space to your communication: your logo, brand, the company, advertising messages, product images and services of every kind of scope.

We have created a new collection with care for the human smile. Make sure to be always on faces of your customers. As a socially responsible company we take responsibility for their health and safety.

SafeTouch Antibacterial™

an ideal solution for public places where the pen is passed on from hand to hand, and where children play.

An antibacterial component added to the plastic is active through out the entire life cycle of the pen.

After 24h 90% of bacteria are killed.

The antibacterial effect has been confirmed and certified.

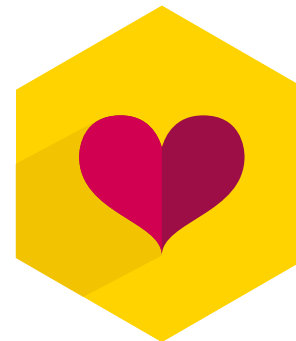

Each day
we are exposed to
pathogenic microbes
on various surfaces.



WATCH THE VIDEO

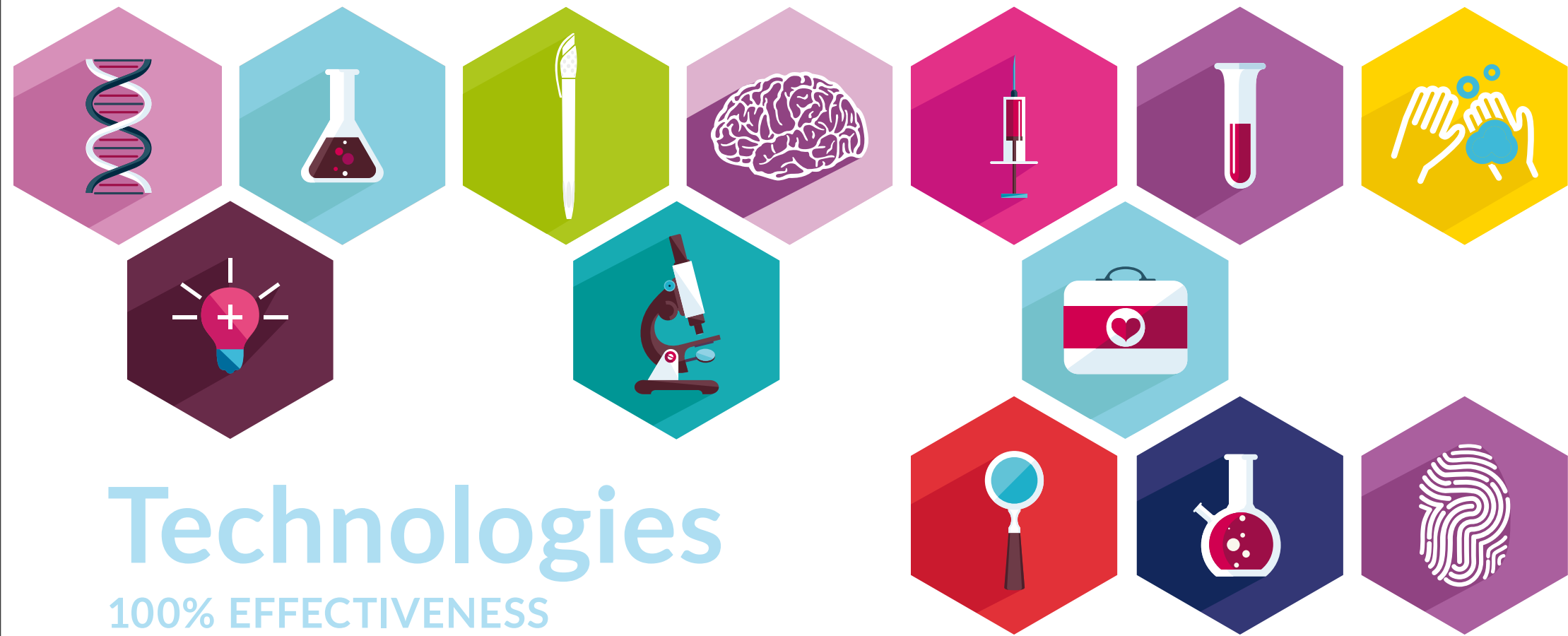

Technologies

100% EFFECTIVENESS
in pathogenic bacteria reduction within 24H

[en] The biostatic effect has been confirmed by laboratory studies. The studies were performed in accordance with the ASTM 2149 Standard. The tests were carried out on bacteria representing two groups – Golden Staph (Staphylococcus aureus,) E. Coli, and also on fungi. The antibacterial added to the plastic is active throughout the entire lifecycle of the pen. It destroys 90% of pathogenic bacteria and fungi. The material is completely safe for the skin.

[ru] Биостатическая эффективность серии подтверждена лабораторными исследованиями, выполненными в соответствии со стандартом ASTM 2149. Тесты проведены на самых распространенных бактериях (Staphylococcus aureus «Стафилококк золотистый», Escherichia coli «Кишечная палочка») Материал безопасен для кожи и уничтожает до 90% вредных бактерий. Антибактериальные свойства сохраняются в течение всего периода использования.

[pl] Efekt biostatyczny został potwierdzony badaniami laboratoryjnymi. Badanie zgodne z normą – Norma ASTM 2149. Badanie przeprowadzono na bakteriach będących przedstawicielami dwóch grup: Gronkowiec złocisty (S.aureus) E.coli oraz na grzybach. Dodatek antybakteryjny zawarty w plastiku jest aktywny przez cały okres użytkowania długopisu. Niszczą 90% bakterii chorobotwórczych i grzybów. Materiał jest całkowicie bezpieczny dla skóry.

[de] Biostatischer Effekt wurde in den Laboruntersuchungen laut der Norm ATSM 2149 bestätigt. Die Untersuchung wurde auf Bakterien aus zwei Gruppen Staphylokokkus (s.aureus) E.coli und auf Pilzen durchgeführt. Der antibakterielle Zusatz in dem Kunststoff ist die ganze Zeit des Kugelschreibersgebrauchs aktiv. Er zerstört 90% der krankheitserregenden Bakterien und Pilzen. Dieses Material ist für die Haut ganz sicher.

SPECIAL SERVICES

IMMERSE YOURSELF IN A WORLD OF UNLIMITED POSSIBILITIES. HERE, EVERY IDEA BECOMES REALITY. JOIN IN OUR FANTASY AND COMPOSE SOMETHING UNIQUE. CREATE A PEN IN THE PERFECT COLORS FOR YOU!



[en] Our specialized production is what sets us apart and what will distinguish your brand. Thanks to our customized services, you can have an original and characteristic novelty item. Fantasy as we see it means the unlimited selection and composition of your own pen. Our customers have at their disposition a full gamut of Pantone colors, extraordinary brocade prints, and distinctive polymer labels. Individually designed clips and photo-quality digital prints are just

some of the services that let you effectively promote your brand. You may select colors and methods of personalization that are ideally suited for expressing your brand identity, and by choosing the Swing model pen, you gain an increased advertising space as well as an original and mobile way of delivering information that displays your brand in line with the 360° concept.

[ru] Создание оригинальной промо-продукции, работа с широкой палитрой корпоративных цветов, брокад, полимерные наклейки – это лишь некоторые преимущества работы с Lesse Pen. Мы предлагаем неограниченные возможности для продвижения товаров и услуг на рынке посредством уникального ассортимента промо-ручек. Для эффективного продвижения своего бренда вы можете выбрать

не только цвет и форму креативных решений, предложенных Lesse Pen, но и размер, область и метод персонализации. Например, выбирая модель Swing, вы получаете и широкий диапазон возможностей для реализации дизайнерских решений в цвете, и расширенную зону для персонализации, и оригинальную подачу рекламных сообщений, позволяющей раскрыть бренд на 360°.



100% creativity



individual solution



unlimited possibilities

[pl] Nasza produkcja specjalna to coś co wyróżnia nas i wyróżni Waszą markę. Dzięki usługom specjalnym zyskujemy oryginalny i charakterystyczny gadżet. Fantazja to niczym nieograniczony dobór i kompozycja własna długopisu. Do dyspozycji naszych klientów oddajemy pełną gamę kolorów Pantone, wyjątkowe nadruki brokatowe i naklejki polimerowe. Klipsy w indywidualnie zaprojektowanym kształcie i nadruki cyfrowe zachowujące jakość fotografii to

usługi, które pozwalają efektywniej promować własną markę. Dobierasz kolor i metodę personalizacji idealne dostosowane do własnej identyfikacji, dodatkowo wybierając długopis typu Swing zyskujesz powiększony obszar pod reklamę, a także oryginalny, ruchomy sposób przekazu informacji, który pozwala na pokazanie marki zgodnie z ideą 360°.

[de] Unsere Sonderproduktion ist etwas, was uns auszeichnet und wird auch Eure Marke auszeichnen. Dank der speziellen Dienstleistungen gewinnen wir ein originelles und charakteristisches Gadget. Phantasie, das ist eigene unbegrenzte Auswahl und Vollendung des Kugelschreibers. Zur Verfügung unserer Kunden geben wir die volle Farbenpalette Pantone, außergewöhnliche Brokaturaufdrücke und Polymeraufkleber, die Clips nach individuellem Gestaltungsentwurf und die Digitalaufdrücke, die

Bilderqualität aufbewahren. Das sind Dienstleistungen, die erfolgreiche Werbung eigener Marke ermöglichen. Du wählst die Farbe und Personalisierungsmethode aus, die an deine eigene Identifikation angepasst sind Wenn du den SWING – Kugelschreiber wählst, dann gewinnst du größere Werbefläche und originelle, interessante Weise des Informationsaustausches, die das Markenzeigen, nach der 360 Grad Idee ermöglicht.

SWING

Can a promotional pen may prove to be creative marketing tool?

- original and distinctive gadget of ideas 360°
- unlimited colors production – special assembly and inner tube
- within Pantone range of colors – perfect reflection of Corporate Identity
- twice larger printable area and unlimited graphics capabilities



Swing Standard

[ru]

[pl]

[de]

Assembly components within Lecce Pen standard range of colors, white inner tube and transparent barrel. Min. quantity 1.000 pcs

Сборка ручек в рамках стандартной палитры цветов Lecce Pen с вращающимся цилиндром белого цвета внутри корпуса.

Montaż elementów w ramach standardowych kolorów Lecce Pen z białą tubką rotującą wewnątrz oraz transparentnym korpusem. Min. ilość 1.000 szt.

Sondermontage im Rahmen der Standardfarben Lecce Pen mit weißer, drinnen rotierender Tube. Mindestmenge 1.000 Stück.

Swing Special Colors

Special assembly all of components within Pantone range of colors. Min. quantity 15.000 pcs

Сборка ручекс вращающимся цилиндром внутри корпуса в цветах по Pantone.

Montaż specjalny wszystkich elementów w ramach palety barw Pantone. Min. ilość 15.000 szt.

Sondermontage und drinnen rotierende Tube im Rahmen der Farbenpalette Pantone Mindestmenge 15 000 Stück

SWING

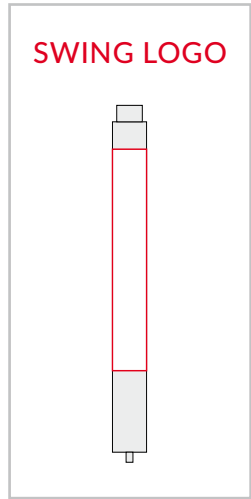

Standard colors

top
solid colors

03 05 08 18 25 35

clip
solid colors

01

head
solid colors

03 05 08 18 25 35

barrel
transparent colors

90

grip
solid colors

01 03 05 08 18 25 35

tip
solid colors

01

top
chrome color

48

clip
transparent colors

90 63 67 73 94

head
transparent frost colors

90 63 67 73 94

grip
transparent colors

90 63 67 73 94 95

tip
transparent colors

90 63 67 73 94

X-Five Swing F5S..

Create a pen in the perfect colors for you!

Fantasy

[ru]

[pl]

[de]

Special assembly within Lecce Pen colors.
MOQ 1.000 pcs.

Сборка ручек в рамках стандартной палитры цветов Lecce Pen

Montaż specjalny w ramach kolorów Lecce Pen. Min. ilość 1.000 szt.

Sondermontage im Rahmen der Farben Lecce Pen. Mindestmenge 1.000.

Fantasy Special

Special assembly within Pantone range of colors minimum quantity 15.000 pcs.

Сборка ручек в рамках стандартной палитры цветов Pantone

Montaż specjalny w ramach kolorów palety Pantone. Min. ilość 15.000 szt.

Sondermontage im Rahmen der Farben Pantone. Mindestmenge 15.000 Stück



FANTASY SERVICE



X-Five Fantasy F5..

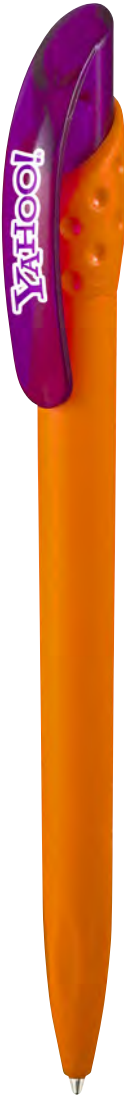

Golf Fantasy FGL..



Kiki Fantasy FK..



Tris Fantasy FTR..



Italian design - Patent



EU Production



Security plastic



Dokumental Ink

FANTASY SERVICE



top
solid colors



clip
solid colors



head
solid colors



barrel
solid colors



barrel
transparent frost colors



grip
solid colors



tip
solid colors



top
chrome color



clip
transparent colors



head
transparent frost colors



barrel
transparent colors



grip
transparent colors



tip
transparent colors



clip
solid colors



head
solid colors



barrel
solid colors



barrel
solid frost colors



clip
transparent colors



head
transparent colors



barrel
transparent colors



X-Five Fantasy F5..

Golff Fantasy FGL..

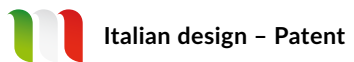



clip
solid colors

01

clip
solid frost colors

03 05 08 25 18 35

head
solid frost colors

01 03 05 08 25 18 35

barrel
solid colors

01

barrel
transparent colors

70 63 67 62 73 94

clip
transparent frost colors

90 63 67 73 94

head
transparent frost colors

90 63 67 73 94

barrel
solid frost colors

03 05 08 11 18 25 35

barrel
transparent frost colors

90 63 67 73 94



push
solid colors

01 03 05 08 10 25 18 35

clip
solid colors

01 03 05 08 10 25 18 35

barrel
solid colors

01 03 05 08 10 25 18 35

tip
solid colors

01 03 05 08 10 25 18 35

tip
chrome colors

48

Kiki Fantasy FK..



Italian design - Patent



EU Production



Security plastic



Dokumental Ink

Tris Fantasy FTR..

PMS PRODUCTION

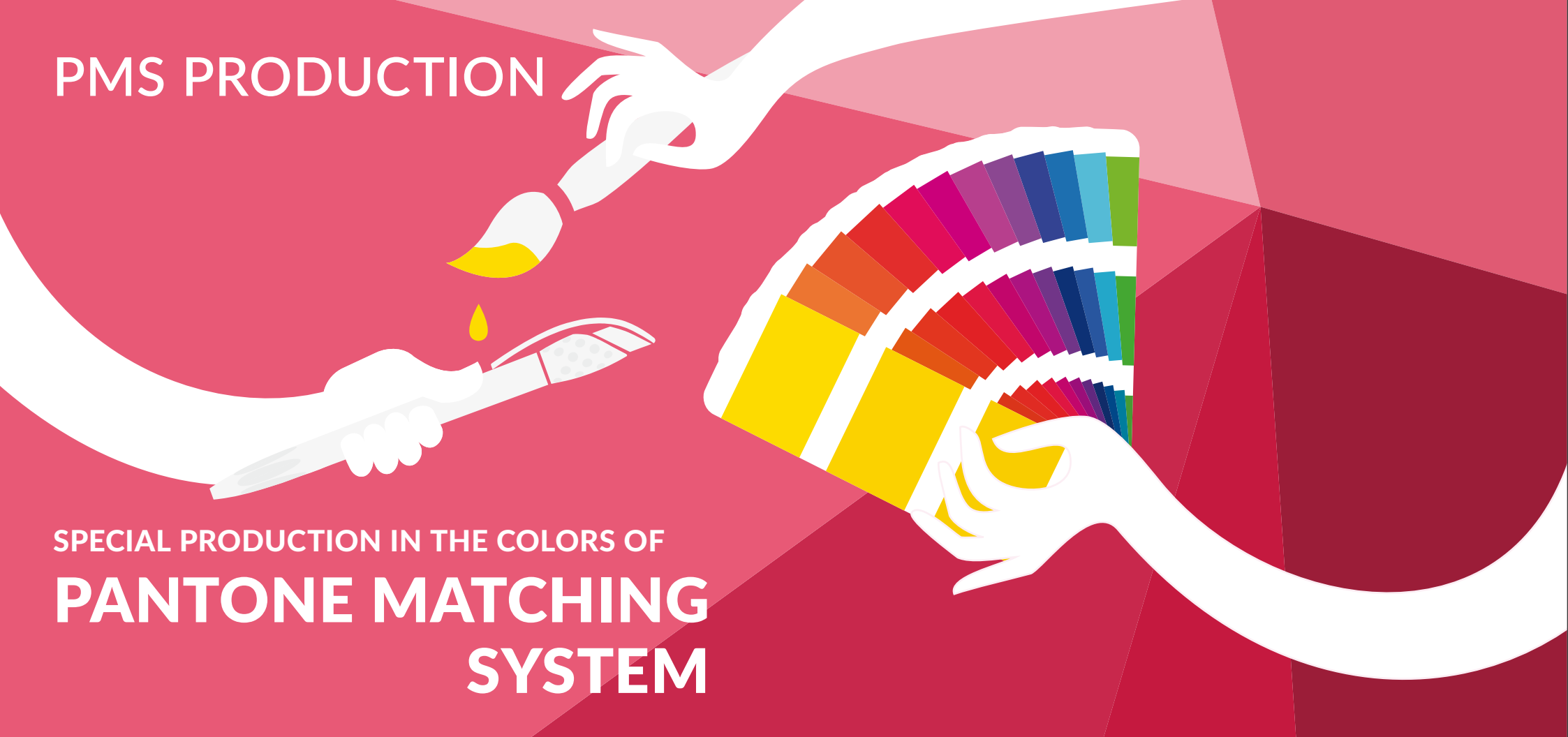

SPECIAL PRODUCTION IN THE COLORS OF PANTONE MATCHING SYSTEM

We are offering customized pens, representing your Corporate Identity with the perfect colors. All our models can be produced in colors you choose.

PMS

[ru]

[pl]

[de]

Special production and assembly within Pantone range of colors minimum quantity 15.000 pcs.

Сборка ручек в рамках стандартной палитры цветов Pantone.

Produkcja i montaż specjalny w ramach kolorów palety Pantone. Min. ilość 15.000 szt.

Sondermontage im Rahmen der Farben Pantone Mindestmenge 15.000 Stück

PMS PRODUCTION



X-Five F5..



Golff FGL..



Kiki FK..



Tris FTR..



Italian design - Patent



EU Production



Security plastic



Dokumental Ink

SPECIAL CLIP



Looking for perfect way to show your brand?
Check our clip fantasy!

To every logo, its own clip choose
between the three versions of clip standard
which best emphasises your logo or
**CREATE YOUR OWN SPECIAL
SHAPE ON CLIP**

Clip Logo Standard

[ru]

[pl]

[de]

Special assembly within Lecce Pen standard range of colors, with standard white clip, minimum quantity (pcs) 1.000

Сборка ручек в рамках стандартной палитры цветов Lecce Pen со стандартным клипом

Montaż specjalny w ramach standardowych kolorów Lecce Pen z klipsem standardowym w kolorze białym, ilość minimalna 1.000

Sondermontage im Rahmen der Standardfarben Lecce Pen mit Weißstandard Klipp Mindestmenge 1.000 Stück

Clip Logo Special

Special assembly within Lecce Pen standard range of colors, with special clip, minimum quantity (pcs) 1.000

Сборка ручек в рамках стандартной палитры цветов Lecce Pen с индивидуальным клипом

Montaż specjalny w ramach standardowych kolorów Lecce Pen z klipsem specjalnym, ilość minimalna 1.000

Sondermontage im Rahmen der Standardfarben Lecce Pen mit spezieller Klipp Mindestmenge 1.000 Stück

SPECIAL CLIP



32 × 45 mm
32 × 65 mm
Silkscreen printing
05 × 45 mm
Pad printing
05 × 60 mm
Digital overprint

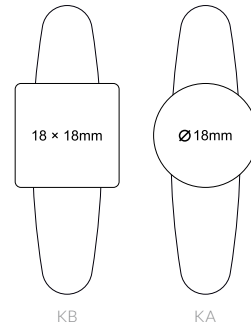

Standard Clip Logo - Printing

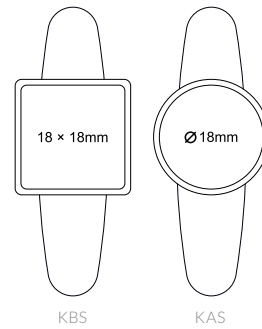

Standard Clip Logo - Polimere sticker



Special Logo Clip (2D & 3D)
Maximum size 25 × 50 mm

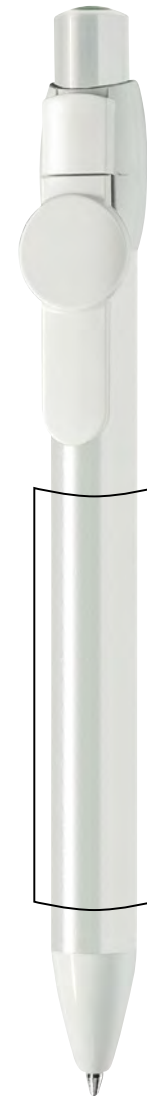

34 × 60 mm
Silkscreen printing
06 × 45 mm
Pad printing
06 × 60 mm
Digital overprint
38,3 × 91 mm
Digital printing 360°

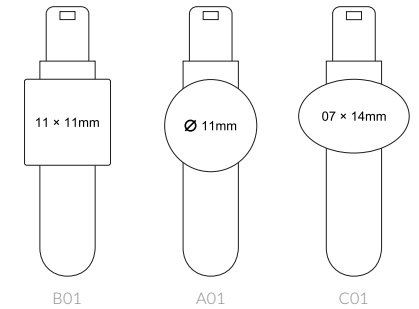

Standard Clip Logo - Printing

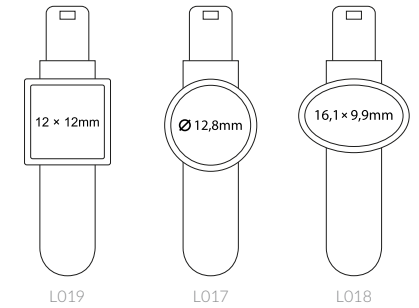

Standard Clip Logo - Polimere sticker



Special Logo Clip (2D & 3D)
Maximum size 20 × 40 mm

Otto Clip Logo Standard & Special

Airy Clip Logo Standard & Special



Italian design - Patent



EU Production



Security plastic



Dokumental Ink



**Otto Clip Logo
Standard FOT..K..**

**Otto Clip Logo
Special FOT..K..**



Italian design - Patent



EU Production



Security plastic



Dokumental Ink

Standard colors

push
solid colors



push
transparent colors



head
solid colors



barrel
solid colors



barrel
solid frost colors



barrel
transparent frost colors



Size

13 × 148 mm

Finishing

Solid frost barrel
& solid accessories

Mechanism

Push

Ink colors

Blue - standard
Black - on demand

Refill type

Model: X-20
Ink. Dokumental

Optional refill

Model: Jumbo
Ink. Dokumental
MOQ: 1.000

Packing

30/1200

PMS Services

MOQ: 15.000



**Airy Clip Logo
Standard FAR..**

**Airy Clip Logo
Special FAR..K..**

Standard colors

top
chrome color

48

push
solid colors

01

head
solid colors

01

barrel
solid colors

01

barrel
satined colors

47

barrel
transparent colors

67

73

tip
solid colors

01

Colors on demand
MOQ: 10.000

01

120

05

08

10

13

126

124

132

17

18

26

135

136

139

141

35

Size

12 × 139 mm

Finishing

Solid barrel & accessories

Mechanism

Push

Ink colors

Blue – standard
Black – on demand

Refill type

Model: **Parker type refill**
Ink. Dokumental

Optional refill

Model: **X-20**
Ink. Dokumental
MOQ: 1.000

Model: **Jumbo**
Ink. Dokumental
MOQ: 1.000

Packing

25/1000

PMS Services

MOQ: 15.000



DIGITAL

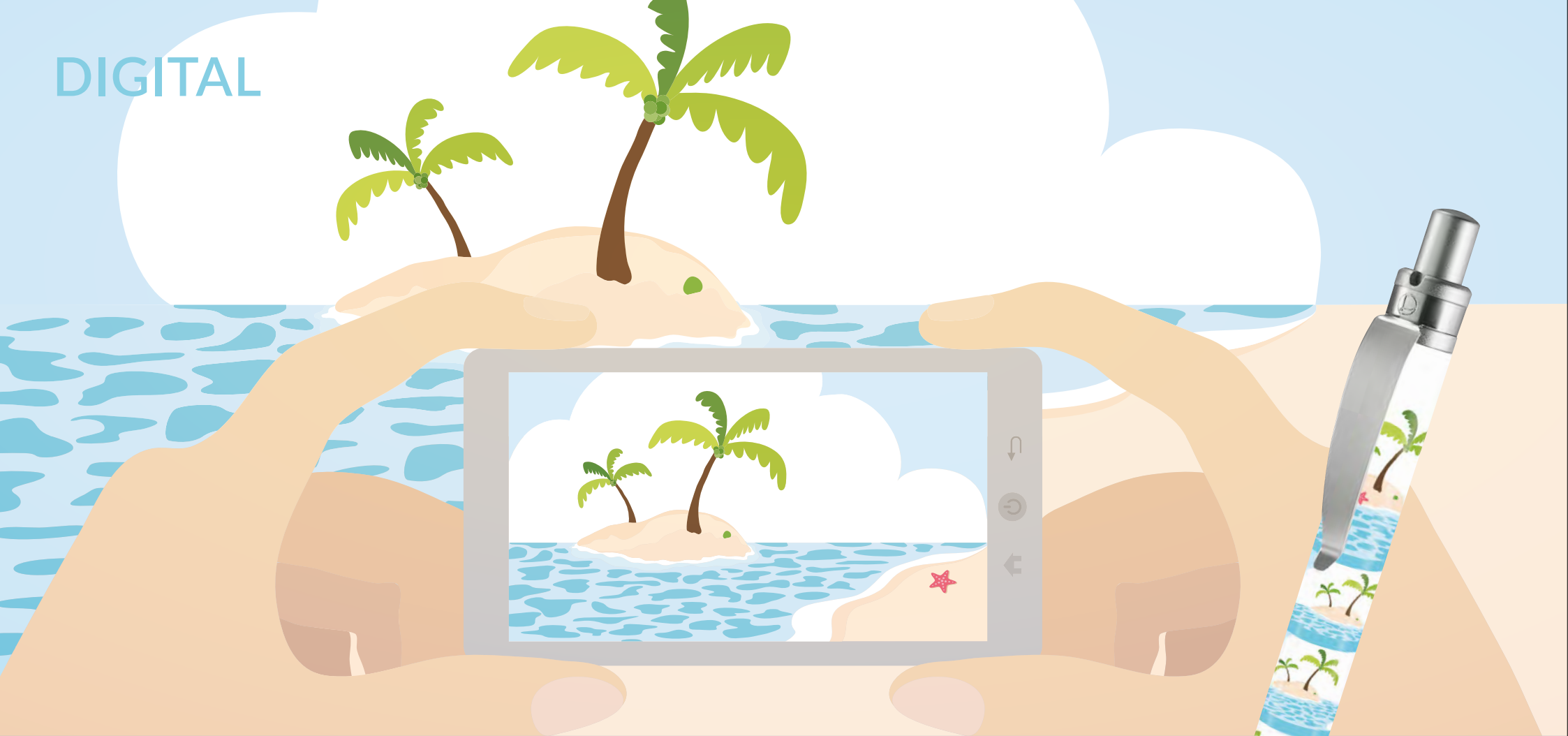

Pens with a real added value. Pictures bring your logo to life.

Unique, original, colorful and bespoke pens, created with innovative printing processes that allows reproduction of photographic images.

Obtained through new printing methods able to reproduce photographic on the whole barrel area, FUTURA model will be customized and colored in an original and unique way. With DGT your creativity has a wide space at its disposal to communicate advertising messages, corporate logos, brands, products and services of every field.



DIGITAL



Printing area

Laser engraving

Digital printing 360°

Product Code _____

Futura Digital 385DGT..W

For other versions of Futura see page 62
To download the photos of HR&LR visit us at www.leccepen.eu

 Italian design

Digital Printing - required file formats: .pdf. jpg. tiff. eps. ai. cdr.
Resolution: 300dpi (minimum).

IMAGE BOX



Image Box

[ru]

4-color process customized paper, mat finishing, internal:
rectangular sponge, minimum quantity 500 pcs

small 1-2 pieces: 56 × 165 mm
medium 3 pieces: 111 × 165mm
large 4-6 pieces: 165 × 167mm

Печать обложки по индивидуальному дизайну.
Ложемент стандартной прямоугольной формы.

малая на 1-2 штуки 56 × 165мм
средняя на 3 штуки 111 × 167мм
большая на 4-7 штуки 165 × 167мм

[pl]

Etui kartonowe z nadrukiem, folia matowa dwustronna,
wewnątrz pianka prostokątna, ilość minimalna 500 szt.

małe 1-2 miejsca: 56 × 165mm
średnie 3 miejsca: 111 × 165mm
duże 4-6 miejsc: 165 × 167mm

[de]

Pappkartonetui mit einem Aufdruck, doppelseitige Mattfolie,
drinnen rechteckiger Schaumstoff, Mindestmenge 500 Stück

klein 1- 2 Plätze: 56 × 165mm
mittelgroß 3 Plätze: 111 × 165mm
groß 4-6 Plätze: 165 × 167mm

IMAGE BOX

Custom packaging

Image Box

Give more space to your communication: your brand, the company, advertising messages, products images and services of every kind of scope.



DRESS PACK

Single pack

Dress your pen to increase its value.

Dress Pack is the new promotional idea that allows us to pack your pens in a sealed single bags, that preserve your product individuality.

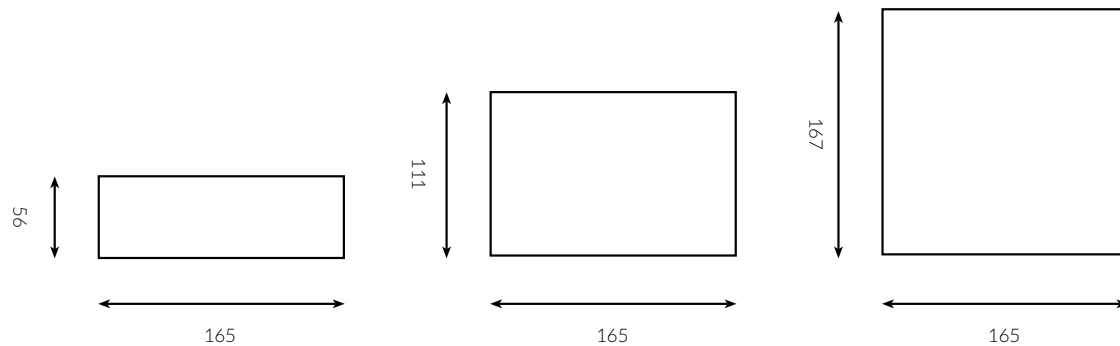

DRESS PACK

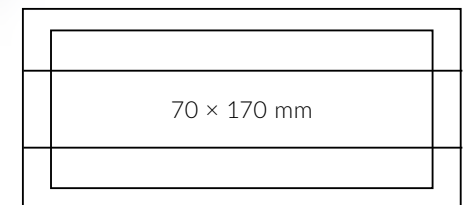



[pl] Istnieje wiele firm. Każda z nich ma tylko jeden cel: wygrać z konkurencją i sprzedać jak najwięcej. Aby to osiągnąć trzeba mieć znaną markę i posiadać dobry wizerunek. Stworzymy taką markę razem. Nasze niestandardowe promocyjne długopisy pomogą zaspokoić Państwa potrzeby marketingowe, zwiększając liczbę potencjalnych klientów oraz wpływając

pozytywnie na decyzje zakupu, a tym samym zwiększając szansę powtórnych zakupów. Jest to możliwe dzięki unikalnym narzędziom promocyjnym, które wzmacniają wiadomość reklamową poprzez wielokrotne ekspozycje.

[de] Es gibt viele Firmen. Jede von ihnen hat nur ein Ziel: mit der Konkurrenz zu gewinnen und so viel wie möglich zu verkaufen. Um das zu erreichen muss man eine bekannte Marke haben und gutes Image besitzen. Schaffen wir so eine Marke zusammen. Unsere einzigartigen Werbekugelschreiber helfen Ihnen Ihre Marketingwünsche zu erfüllen, indem sie Ihre po-

tenzielle Kundenmenge vergrößern, positiv die Kaufentscheidung beeinflussen und gleichzeitig die Chance für nächsten Kauf erweitern. Das alles ist möglich dank der innovativen Werbewerkzeuge durch vielfache Expositionen.

NEW 2016



♪ FORTE

Promote your brand
in a magnificent way!
Take part in the most
COLORED
performance ever!

YOUR BENEFITS

- made in Europe
- unique, patented design
- a variety of finishes
- wide range of colors
- bigger area for personalization

Lecce Pen

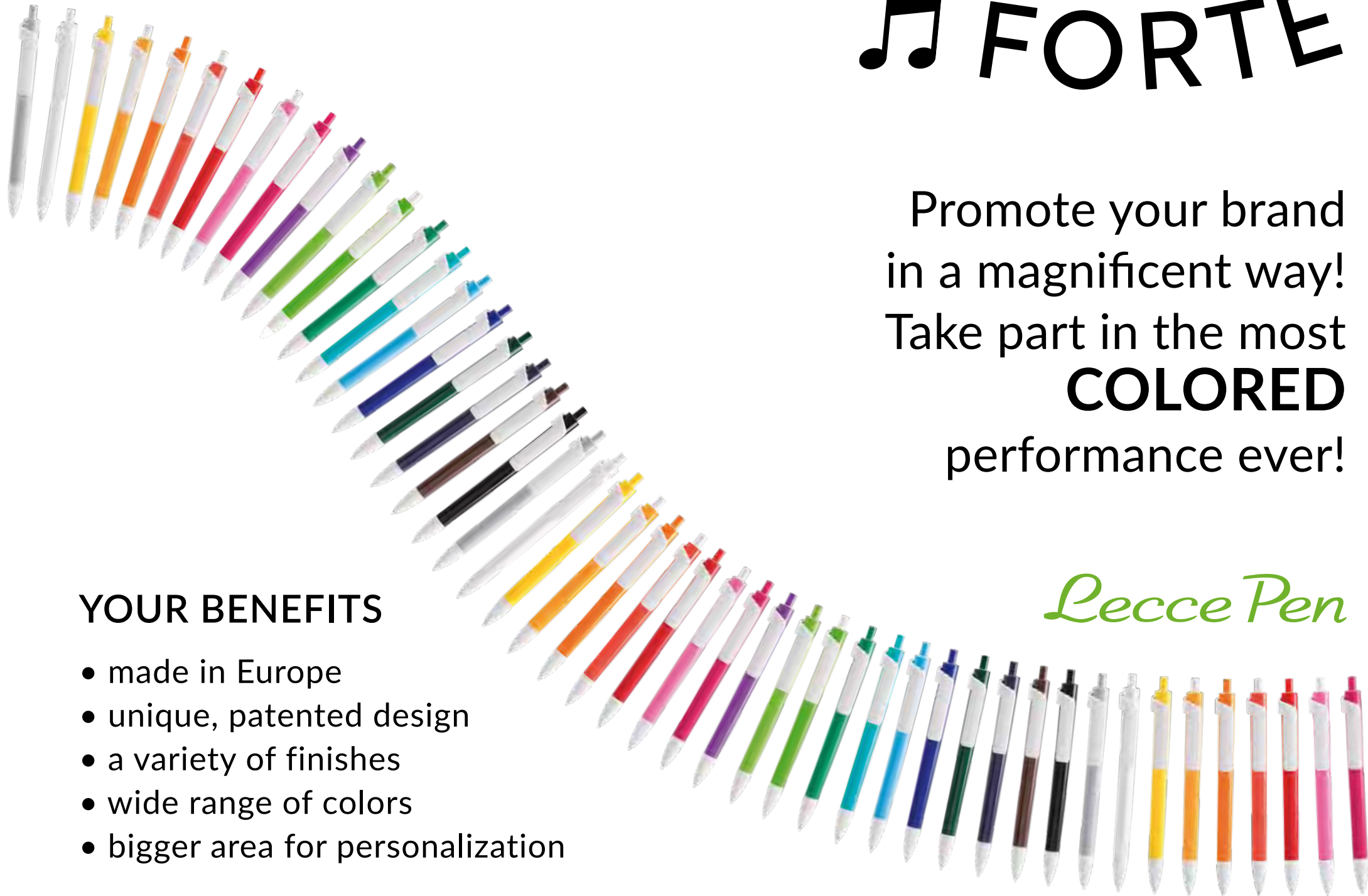

NEW



Round overprint 360°
Brocade decoration
Silkscreen printing



05 x 32 mm
Pad printing
05 x 30 mm
Digital overprint

05 x 50 mm
Pad printing
05 x 70 mm
Digital overprint

Size

10 x 139 mm

Finishing

Solid, soft, neon

Mechanism

Push

Ink colors

Blue – standard
Black – on demand

Refill type

Model: **X-20**
Ink. Dokumental

Optional refill

Model: **Parker type refill**
Ink. Dokumental
MOQ: 1.000

Model: **Parker type gel**
Ink. Dokumental
MOQ: 1.000

Model: **Jumbo refill**
Ink. Dokumental
MOQ: 1.000

Packing

Forte 40/1600
Forte Soft 35/1400

PMS Services

MOQ: 15.000

Forte



Italian design – Patent



EU Production



Security plastic



Dokumental Ink

NEW



01



120



05



08



10



13



126



124

Product Code

Forte 602..W

NEW



132



18



17



135



136



26



139



141



35

Product Code

Forte 602..W



NEW



120



05



08



18



136



35

Product Code

Forte 601..W

NEW



Product Code _____

Forte Neon 607..W



Promotional



30 x 45 mm
Round overprint 360°
Brocade decoration
Silkscreen printing



Laser engraving

05 x 45 mm
Pad printing
05 x 60 mm
Digital overprint



30 x 40 mm
Round overprint 360°
Brocade decoration
Silkscreen printing



Pad printing
Digital overprint

05 x 45 mm
Pad printing
05 x 50 mm
Digital overprint

Size

11 x 148 mm

Finishing

X-Nine: transparent barrel, chrome accessories, metal clip, grip
Novo: solid or transparent barrel, colored or chromed accessories, grip

Mechanism

Push

Ink colors

Blue - standard
Black - on demand

Refill type

Model: **Parker type refill**
Ink. Dokumental

Optional refill

Model: **Parker type gel**
Ink. Dokumental
MOQ: 1.000

Model: **X-20**
Ink. Dokumental
MOQ: 1.000

Model: **Jumbo**
Ink. Dokumental
MOQ: 1.000

Packing

25/1000

PMS Services

MOQ: 15.000

X-Nine // Novo



Italian design - Patent



EU Production



Security plastic



Dokumental Ink



63



67



94



73



95

Product Code _____

X-Nine Lx 228..W

Promotional



Round overprint 360°
Brocade decoration
Silkscreen printing

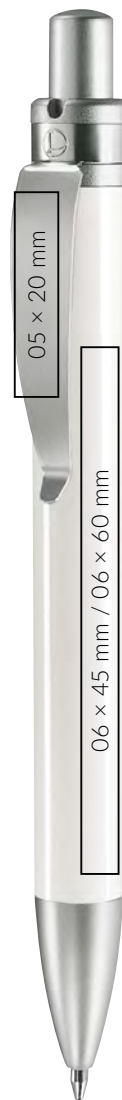

Laser engraving

06 x 45 mm
Pad printing
06 x 60 mm
Digital overprint

Size

12 x 135 mm

Finishing

Solid or transparent barrel,
satinated accessories,
metal clip

Mechanism

Push

Ink colors

Blue – standard
Black – on demand

Refill type

Model: **Parker type refill**
Ink. Dokumental

Optional refill

Model: **Parker type gel**
Ink. Dokumental
MOQ: 1.000

Packing

25/1000

PMS Services

MOQ: 15.000

Futura



Colors on demand
MOQ: 10.000



01



47



67



73

01

120

05

08

10

13

126

124

132

17

18

26

135

136

139

141

35

Product Code

Futura 385..W

Futura 360 Digital Printing see page 45
To download the photos of HR&LR visit us at www.leccepen.eu



Lecce Pen

Promotional



Round overprint 360°
Brocade decoration
Silkscreen printing



06 x 25 mm
Pad printing
05 x 23 mm
Digital overprint

05 x 45 mm
Pad printing

Size

11 x 141 mm

Finishing

Frost-transparent, solid,
fantasy

Mechanism

Push

Ink colors

Blue – standard
Black – on demand

Refill type

Model: **Parker type refill**
Ink. Dokumental

Optional refill

Model: **Parker type gel**
Ink. Dokumental
MOQ: 1.000

Model: **X-20**
Ink. Dokumental
MOQ: 1.000

Model: **Jumbo refill**
Ink. Dokumental
MOQ: 1.000

Packing

30/1200

PMS Services

MOQ: 15.000

X-Five



Italian design – Patent



EU Production



Security plastic



Dokumental Ink

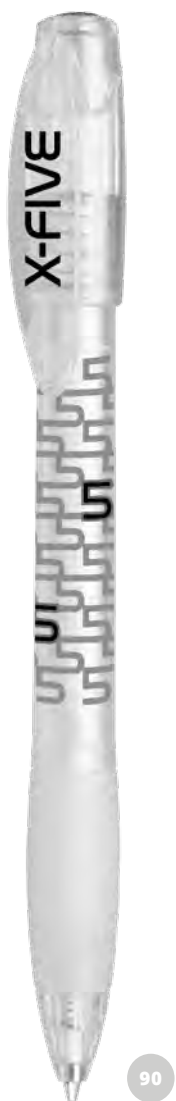

90



63



67



94



73

Product Code

X-Five Frost 219F..RW

For X-Five Swing see page 33
To compose X-Five Fantasy see page 35
To download the photos of HR&LR visit us at www.leccepen.eu



Promotional



Product Code

X-Five 218..RW

For X-Five Swing see page 33
To compose X-Five Fantasy see page 35
To download the photos of HR&LR visit us at www.leccepen.eu

Special Service – X-Five Swing



Product Code _____

X-Five Swing F5S..

For X-Five Swing see page 33
To compose X-Five Fantasy see page 35
To download the photos of HR&LR visit us at www.leccepen.eu

 *Lecce Pen*

Promotional



Round overprint 360°
Brocade decoration
Silkscreen printing



Pad printing
Digital overprint

05 x 45 mm
Pad printing
05 x 55 mm
Digital overprint

Size

11 x 141 mm

Finishing

Solid barrel, colored
or chrome accessories

Mechanism

Push

Ink colors

Blue - standard
Black - on demand

Refill type

Model: **X-20**
Ink. Dokumental

Optional refill

Model: **Parker type refill**
Ink. Dokumental
MOQ: 1.000

Model: **Parker type gel**
Ink. Dokumental
MOQ: 1.000

Model: **Jumbo refill**
Ink. Dokumental
MOQ: 1.000

Packing

40/1600

PMS Services

MOQ: 15.000

Tris



Italian design - Patent



EU Production



Security plastic



Dokumental Ink



Product Code

Tris Chrome 20648..W

To compose Tris Fantasy see page 35
 To download the photos of HR&LR visit us at www.leccepen.eu



Promotional



Product Code _____

Tris 203..W

To compose Tris Fantasy see page 35
To download the photos of HR&LR visit us at www.leccepen.eu



Product Code _____

Tris 202..W

To compose Tris Fantasy see page 35
To download the photos of HR&LR visit us at www.leccepen.eu



Promotional



Round overprint 360°
Brocade decoration
Silkscreen printing



05 x 23 mm
Pad printing
05 x 19 mm
Digital overprint

05 x 45 mm
Pad printing
05 x 60 mm
Digital overprint

Size

11 x 147 mm

Finishing

Transparent, frost, solid

Mechanism

Push

Ink colors

Blue - standard
Black - on demand

Refill type

Model: **X-20**
Ink. Dokumental

Optional refill

Model: **Parker type refill**
Ink. Dokumental
MOQ: 1.000

Model: **Parker type gel**
Ink. Dokumental
MOQ: 1.000

Model: **Jumbo refill**
Ink. Dokumental
MOQ: 1.000

Packing

35/1400

PMS Services

MOQ: 15.000

Golff



Italian design - Patent



EU Production



Security plastic



Dokumental Ink



70



63



67



62



94



73

Product Code

Golff Lx 411..W

For antibacterial pen see page 24
To compose Golff Fantasy see page 35
To download the photos of HR&LR visit us at www.leccepen.eu



Promotional



Product Code

Golff Mt 413F..W

For antibacterial pen see page 24
To compose Golff Fantasy see page 35
To download the photos of HR&LR visit us at www.leccepen.eu



Product Code

Golff 410..W

For antibacterial pen see page 24
 To compose Golff Fantasy see page 35
 To download the photos of HR&LR visit us at www.leccepen.eu



Promotional



Round overprint 360°
Brocade decoration
Silkscreen printing



Pad printing
Digital overprint

05 x 45 mm
Pad printing
05 x 60 mm
Digital overprint

Size

11 × 144 mm

Finishing

Frost-transparent, frost-solid,
solid

Mechanism

Push

Ink colors

Blue – standard
Black – on demand

Refill type

Model: **X-20**
Ink. Dokumental

Optional refill

Model: **Parker type refill**
Ink. Dokumental
MOQ: 1.000

Model: **Parker type gel**
Ink. Dokumental
MOQ: 1.000

Packing

40/1600

PMS Services

MOQ: 15.000

Kiki

 Italian design – Patent

 EU Production

 Security plastic

 Dokumental Ink



90



63



67



94



73

Product Code

Kiki Frost 393F..W

For eco pen see pages 14, 16
To compose Kiki Fantasy see page 35
To download the photos of HR&LR visit us at www.leccepen.eu

Promotional



Product Code

Kiki Mt 396F..W

For eco pen see pages 14, 16
To compose Kiki Fantasy see page 35
To download the photos of HR&LR visit us at www.leccepen.eu



01



03



05



08



18



25



35

Product Code

Kiki 390..W

For eco pen see pages 14, 16
To compose Kiki Fantasy see page 35
To download the photos of HR&LR visit us at www.leccpen.eu



Promotional



Round overprint 360°
Brocade decoration
Silkscreen printing



06 x 35 mm
Pad printing
09 x 47 mm
Digital overprint

05 x 45 mm
Pad printing
05 x 60 mm
Digital overprint

Size

13 x 148 mm

Finishing

Solid frost, transparent
frost, solid

Mechanism

Push

Ink colors

Blue - standard
Black - on demand

Refill type

Model: **X-20**
Ink. Dokumental

Optional refill

Model: **Jumbo refill**
Ink. Dokumental
MOQ: 1.000

Packing

30/1200

PMS Services

MOQ: 15.000

Otto



Italian design - Patent



EU Production



Security plastic



Dokumental Ink

DGT on the clip



Product Code _____

Otto Frost 504F..W

To create your Special Clip see page 41
To download the photos of HR&LR visit us at www.leccepen.eu



Product Code _____

Otto 500..W

To create your Special Clip see page 41
 To download the photos of HR&LR visit us at www.leccepen.eu



Promotional



Round overprint 360°
Brocade decoration
Silkscreen printing



05 x 45 mm
Pad printing
05 x 60 mm
Digital overprint

Size

11 x 138 mm

Finishing

Solid or transparent frost barrel, transparent accessories

Mechanism

Push

Ink colors

Blue - standard
Black - on demand

Refill type

Model: **X-20**
Ink. Dokumental

Optional refill

Model: **Parker type refill**
Ink. Dokumental
MOQ: 1.000

Model: **Parker type gel**
Ink. Dokumental
MOQ: 1.000

Model: **Jumbo**
Ink. Dokumental
MOQ: 1.000

Packing

45/1800

PMS Services

MOQ: 15.000

Jocker



Italian design - Patent



EU Production



Security plastic



Dokumental Ink

Promotional



Round overprint 360°
Brocade decoration
Silkscreen printing



Pad printing
Digital overprint

05 x 45 mm
Pad printing
05 x 60 mm
Digital overprint

Size

11 × 138 mm

Finishing

Solid or transparent frost barrel, transparent accessories

Mechanism

Push

Ink colors

Blue - standard
Black - on demand

Refill type

Model: **X-20**
Ink. Dokumental

Optional refill

Model: **Parker type refill**
Ink. Dokumental
MOQ: 1.000

Model: **Parker type gel**
Ink. Dokumental
MOQ: 1.000

Model: **Jumbo**
Ink. Dokumental
MOQ: 1.000

Packing

45/1800

PMS Services

MOQ: 15.000

X-One



Italian design - Patent



EU Production



Security plastic



Dokumental Ink

Promotional



90



63



67



94



73

Product Code _____

Jocker 408..W



Product Code _____

Jocker Frost 407F..W

Promotional



Product Code _____
X-One 212..W



90



63



67



94



73

Product Code

X-One Frost 213F..W



Promotional

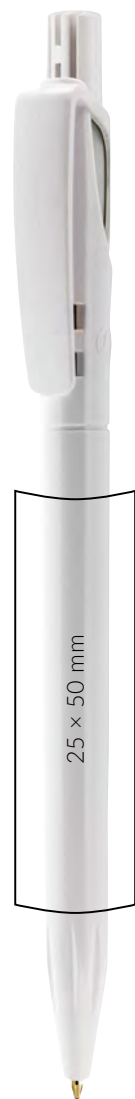

Round overprint 360°
Brocade decoration
Silkscreen printing



Pad printing
Digital overprint

04 x 45 mm
Pad printing
04 x 50 mm
Digital overprint

Size

08 x 138 mm

Finishing

Solid or transparent barrel,
colored accessories

Mechanism

Push

Ink colors

Blue – standard
Black – on demand

Refill type

Model: **X-10 DUO**
Ink. Dokumental

Packing

50/2000

PMS Services

MOQ: 15.000

Twin

 Italian design – Patent

 EU Production

 Security plastic

 Dokumental Ink



Product Code _____

Twin Mt 161..W



Promotional



Product Code _____

Twin 16101..W



70



67



94



73



95

Product Code _____

Twin Lx 162..W

Promotional



Round overprint 360°
Brocade decoration
Silkscreen printing

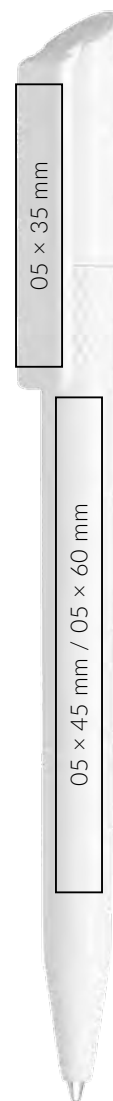

Pad printing
Digital overprint

05 x 45 mm
Pad printing
05 x 60 mm
Digital overprint

Size

10,5 × 143 mm

Finishing

Solid monocolored ballpen

Mechanism

Twist

Ink colors

Blue – standard
Black – on demand

Refill type

Model: **X-20**
Ink. Dokumental

Optional refill

Model: **Jumbo refill**
Ink. Dokumental
MOQ: 1.000

Packing

50/2000

PMS Services

MOQ: 15.000

Twisty

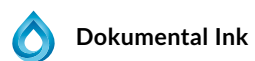
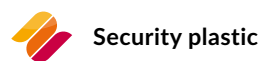



Product Code _____

Twisty 176..W

For antibacterial pen see page 26
 To download the photos of HR&LR visit us at www.leccepen.eu



Promotional



Digital overprint
Pad printing

35 × 35 mm

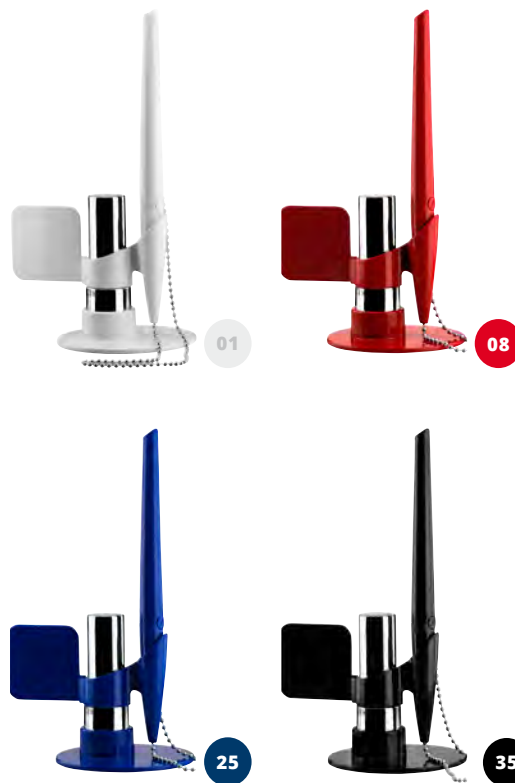

Size

88,83 × 75 mm

Finishing

Standing ballpen, solid colors, chromed accessories and metal chain, sticker

Mechanism

Push

Ink colors

Blue – standard

Refill type

Model: **Eco style**
Ink. Dokumental

Packing

1/30

PMS Services

MOQ: 2.000

Flag 22048..EX



Italian design – Patent



EU Production



Security plastic



Dokumental Ink



Promotional



Flag Special FFS..



Italian design - Patent



EU Production



Security plastic



Dokumental Ink

Size

88,83 × 75 mm

Finishing

Special assembly within Lecce Pen standard range of colors, with special flag, MOQ, 1.000

Mechanism

Push

Ink colors

Blue - standard

Refill type

Model: **Eco style**
Ink: Dokumental
MOQ: 1.000

Packing

1/30

PMS Services

MOQ: 2.000

TECHNICAL INFORMATION

Color on demand	[ru]	[pl]	[de]
Special production in the colors of the Lecce Pen's offer.	Специальное производство в цветах заказчика, на основе палитры Lecce Pen.	Produkcja specjalna kolorów zgodnych z paletą oferowaną przez Lecce Pen. Ilość minimalna 15.000 szt.	Sonderproduktion in den Farben des Lecce Pen Angebotes
PMS			
Special production in the colors of Pantone Management System (PMS).	Специальное производство в цветах Pantone Management System (PMS).	Produkcja specjalna kolorów zgodnych z paletą Pantone (PMS). Ilość minimalna 15.000 szt.	Sonderanfertigung in den Farben des Pantone-Management-Systems (PMS).
 Italian design – patent			
All our products are patented. All rights reserved.	Все продукты Lecce Pen запатентованы. Все права защищены.	Wszystkie oferowane produkty są opatentowane. Wszystkie prawa zarezerwowane.	Alle unsere Produkte sind patentiert. Alle Rechte vorbehalten.
 EU Production			
Our pens are produced in Europe and also refills (Switzerland or Italy).	Наши ручки производятся в Европе, стержни – из Италии или Швейцарии.	Nasze produkty zostały wyprodukowane w Europie, wkłady pochodzą ze Szwajcarii lub Włoch.	Die Kugelschreiber und auch Minen sind in Europa (Schweiz oder Italien) produziert.
 Dokumental Ink			
Ink cartridges, which we offer in our pens, are documented by certificate ISO 12757-1 and/or 12757-2.	Качество стержней для наших ручек подтверждено сертификатом ISO 12757-1 и/или 12757-2.	Tusz we wkładach, które oferujemy w naszych długopisach, jest udokumentowany certyfikatem ISO 12757-1 i/lub 12757-2.	Tintenpatronen, die wir in unserem Stifte bieten, werden durch das Zertifikat ISO 12757-1 und / oder 12757-2 dokumentiert.
 Security Plastic			
The ABS material, which we use to produce pens, is comply with REACH Regulations (EC No 1907/2006) Appendix II. Biome Bioplast GS 2189 is a plasticize-free, thermoplastic bio-resin. The resin is fully biodegradable and accredited to composting standards (e.g. EN13432, ASTM D6400, Vincotte OK Compost). According to EEC Directive 67/548 and further modifications, EcoLine product is not considered dangerous.	АБС-материал, который используется при производстве ручек, полностью регулируется регламентом Европейского союза REACH (EC No 1907/2006) и Appendix II. Термопластичный биополимер Biome Bioplast GS 2189 не содержит пластификаторов и полностью разлагается микроорганизмами, что соответствует стандартам компостирования (таким, как EN13432, ASTM D6400, Vincotte OK Compost). Продукт EcoLine, в соответствии с Директивой 67/548 ЕЕС и ее дальнейшими модификациями, считается безопасным.	Materiał ABS, który jest wykorzystywany do produkcji naszych długopisów, jest zgodny z rozporządzeniem REACH (EC No 1907/2006) aneks II. Biome Bioplast GS2189 jest wolny od plastyfikatorów, bio-żywiczy termoplastycznej. Żywica jest w pełni biodegradowalna i akredytowana do standardów kompostowania (np. EN13432, ASTM D6400, Vincotte OK Compost). Zgodnie z dyrektywą EWG 67/548 i późniejszymi zmianami, produkty EcoLine nie są uważane za niebezpieczne.	Das ABS-Material, das wir benutzen, um Stifte zu produzieren, ist im Einklang mit REACH-Verordnung (EG 1907/2006) Anhang II. Biome Bioplast GS 2189 ist eine weichmacherfreies, thermoplastisches bio-Harz. Das Harz ist vollständig biologisch abbaubar und akkreditiert zum Kompostierungsstandard (zB EN13432, ASTM D6400, Vincotte OK Compost). Gemäß der EG-Richtlinie 67/548 und weiteren Modifikationen, wird das EcoLine Produkt nicht gefährlich.

COLORS

Solid colors

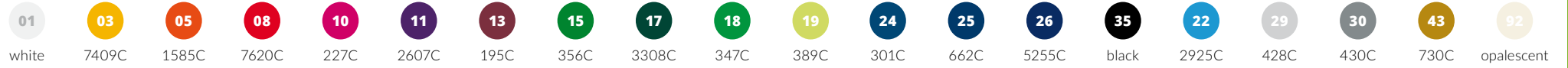

Forte colors

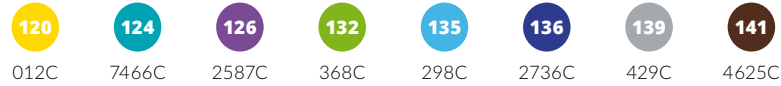

Forte neon colors

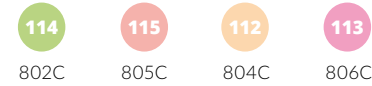

Transparent colors

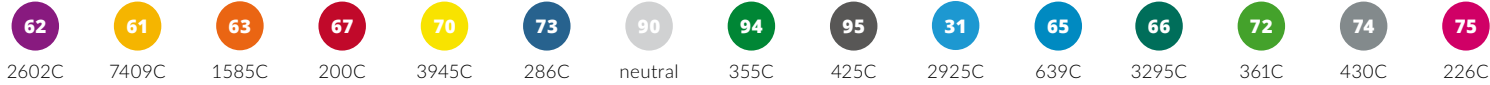

ON DEMAND: Transparent colors

Chrome color



ON DEMAND: Satined colors

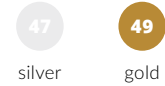

Transparent frost colors

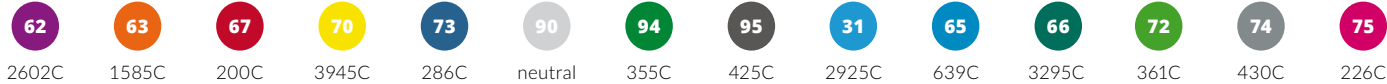

ON DEMAND: Transparent frost colors

Solid frost colors

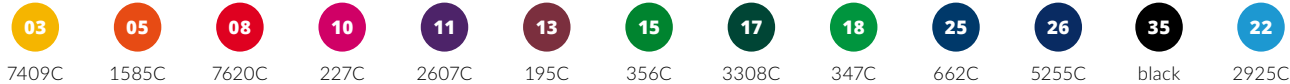

ON DEMAND: Solid frost colors

SafeTouch colors

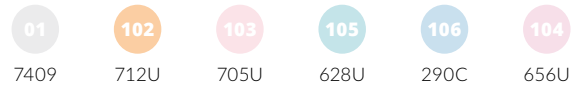

ON DEMAND: SafeTouch colors

 PMS - special production in the colors of Pantone Matching System. MOQ 15.000.

The colors as displayed in the catalogue may differ from the colors of the actual products and serve only as a reference.



Powered by **Happy Gifts** group
www.happygifts.eu